

Modal Excitation

D. L. Brown

University of Cincinnati
Structural Dynamics Research
Laboratory

M. A. Peres

The Modal Shop Inc
Cincinnati, OH

Introduction

- The presentation is concerned with a short tutorial on modal excitation. It will cover:
 - Types of Methods
 - Force Appropriation Methods (Normal Mode)
 - Frequency Response Methods
 - Excitation Signals Types
 - Exciters
 - Impactors
 - Hydraulic and Electro-mechanical
 - Measurement and Signal Processing Considerations

Testing Methods

- Force Appropriation – Is a historical sine testing methods where an array of exciters is tuned to excite single system eigenvector. This methods is used primarily as a method for testing aircraft or space craft and is used by a very small segment of the modal testing community and will not be cover in this talk.
- Frequency Response Functions – In the early sixties estimating modal parameters from FRF measurements became a practical method for determining modal parameters. However, it was the development of FFT which made the method popular. This talk will concentrate upon the excitation methods and equipment for measuring FRF's.

Dynamic Modal Model

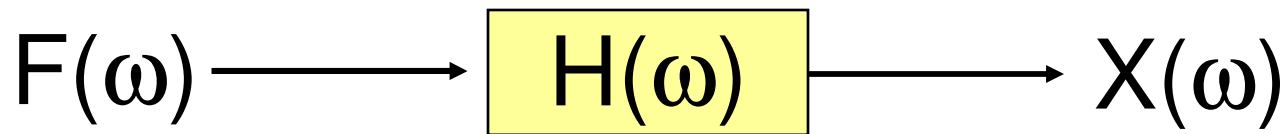

Excitation Input

Response

$$\{X\} = [H] \{F\}$$

Excitation Signals

- The type of excitation signal used to estimate frequency response functions depends upon several factors. Generally, the excitation signal is chosen in order to minimize noise while estimating the most accurate frequency response function in the least amount of time. With the advent of the FFT, excitation signals are most often contain broadband frequency information and are limited by the requirements of the FFT (totally observed transients or periodic functions with respect to the observation window).

Noise Reduction

- Types of noise:
 - Non-Coherent
 - Signal processing (Leakage)
 - Non-Linear

Noise is reduced by averaging in the non-coherent case, by signal processing and excitation type for the leakage case, and by randomizing and averaging for the non-linear case.

Excitation Types

- Steady State
 - Slow Sine Sweep
 - Stepped Sine
- Random
 - True Random
- Periodic
 - Fast Sine Sweep (Chirp)
 - Pseudo Random
 - Periodic Random
- Transient
 - Burst Random
 - Impact
 - Step Relaxation
- Operating

Excitation Signal Characteristics

- RMS to Peak
- Signal to Noise
- Distortion
- Test Time
- Controlled Frequency Content
- Controlled Amplitude Content
- Removes Distortion Content
- Characterizes Non Linearities

Summary Excitation Signal Characteristics

Excitation Signal Characteristics							
	Steady State Sine	Pure Random	Pseudo Random	Random	Periodic Chirp	Impact	Burst Random
Minimize Leakage	No	No	Yes	Yes	Yes	Yes	Yes
Signal-to-Noise Ratio	Very High	Fair	Fair	Fair	High	Low	Fair
RMS-to-Peak Ratio	High	Fair	Fair	Fair	High	Low	Fair
Test Measurement Time	Very Long	Good	Very Short	Fair	Fair	Very Short	Very Short
Controlled Frequency Content	Yes	Yes *	Yes *	Yes *	Yes *	No	Yes *
Controlled Amplitude Content	Yes	No	Yes *	No	Yes *	No	No
Removes Distortion	No	Yes	No	Yes	No	No	Yes
Characterize Nonlinearity	Yes	No	No	No	Yes	No	No

* Special Hardware Required

Modal Testing Set Up

- What's the purpose of the test?
- Application
- Accuracy needs
- Non-linearities
- Testing time
- Expected utilization of the data
- Testing cost
- Equipment availability

Typical modal test configuration: Impact

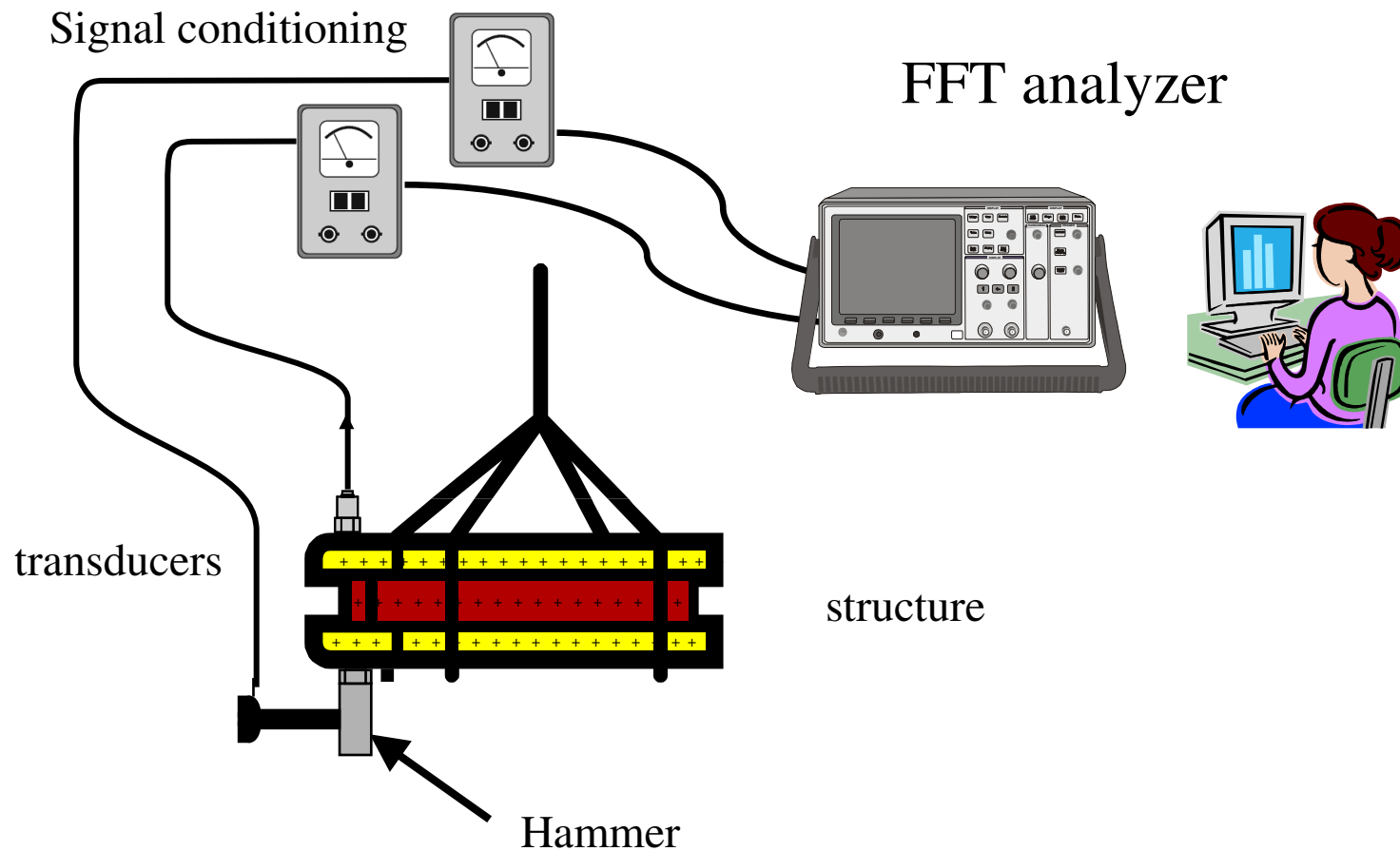

Modal Excitation

Input Spectrum

- Factors controlling the frequency span of the input spectrum
 - Stiffness of the impact tip
 - Compliance of the impacted surface
 - Mass of the impactor
 - Impact velocity
- The input spectrum should roll-off between 10 and 20 dB over the frequency range of interest
 - At least 10 dB so that modes above the frequency range of interest are not excited
 - No more than 20 dB so that the modes in the frequency range of interest are adequately excited

Hammer Calibration

- The load cell of the impactor should be calibrated in its testing configuration since its sensitivity is altered when it is used as part of an impactor.

$$F_{measured} < F_{input}$$

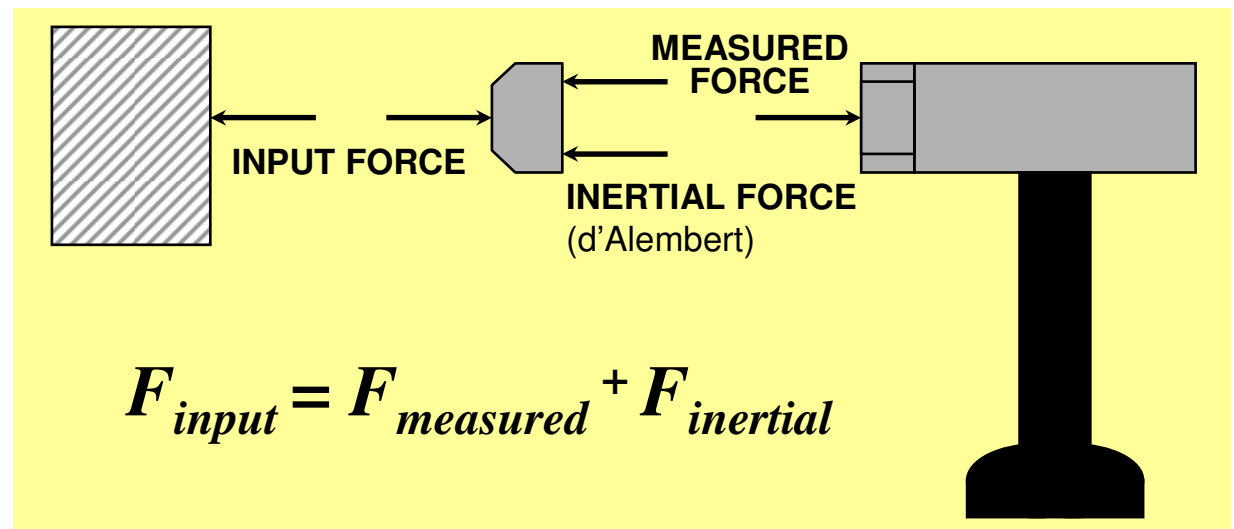

- The difference of the measured force and the input force depends on the *effective* mass of the impactor and the impact tip.

Ratio Calibration

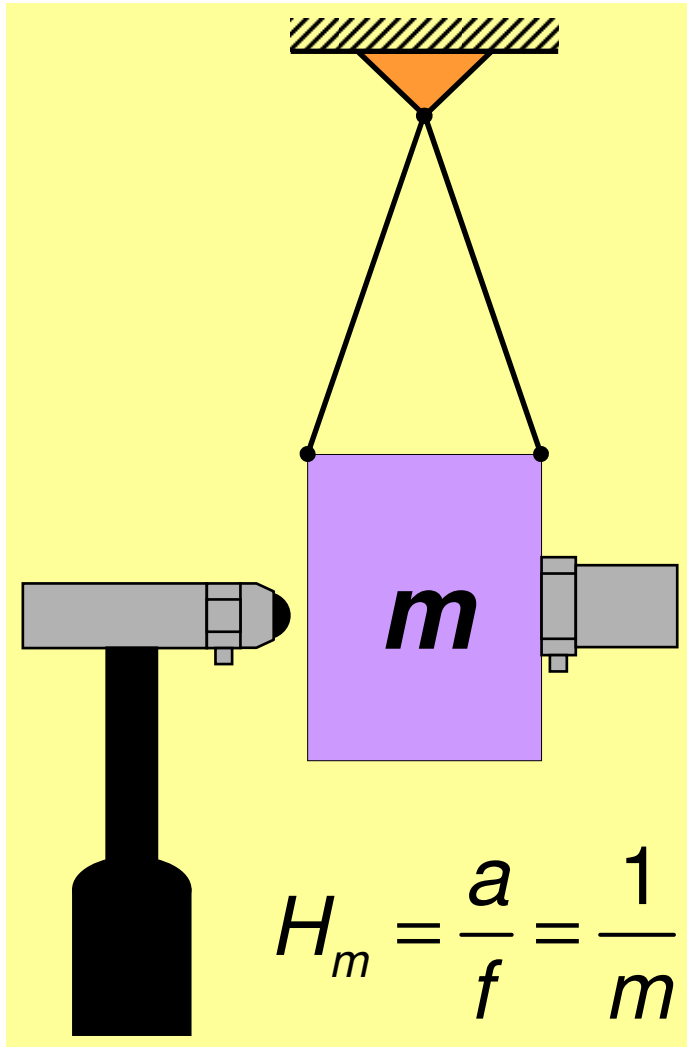

$$H \left[\frac{g}{lb} \right] = \frac{C_a \left[\frac{g}{V} \right] * V_a [V]}{C_f \left[\frac{lb}{V} \right] * V_f [V]}$$

Determine ratio of C_a/C_f from V_a/V_f for calibration mass.

$$\frac{C_a}{C_f} = \frac{1}{mH_m} \quad \text{Where: } H_m = \frac{V_a}{V_f}$$

Hammer Calibration Pictures

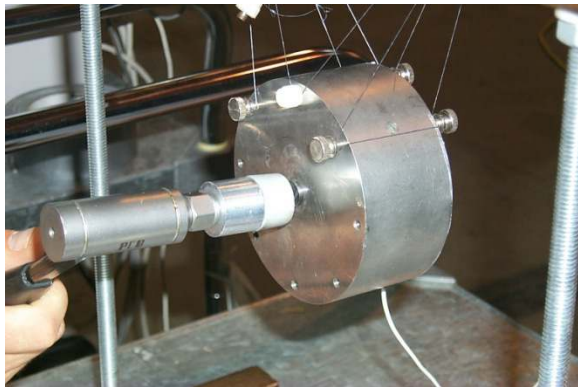

Modal Excitation Techniques

- Impact Hammers
- Shakers



Impact Testing

- Easy to use in the field
- No elaborate fixturing
- Fast

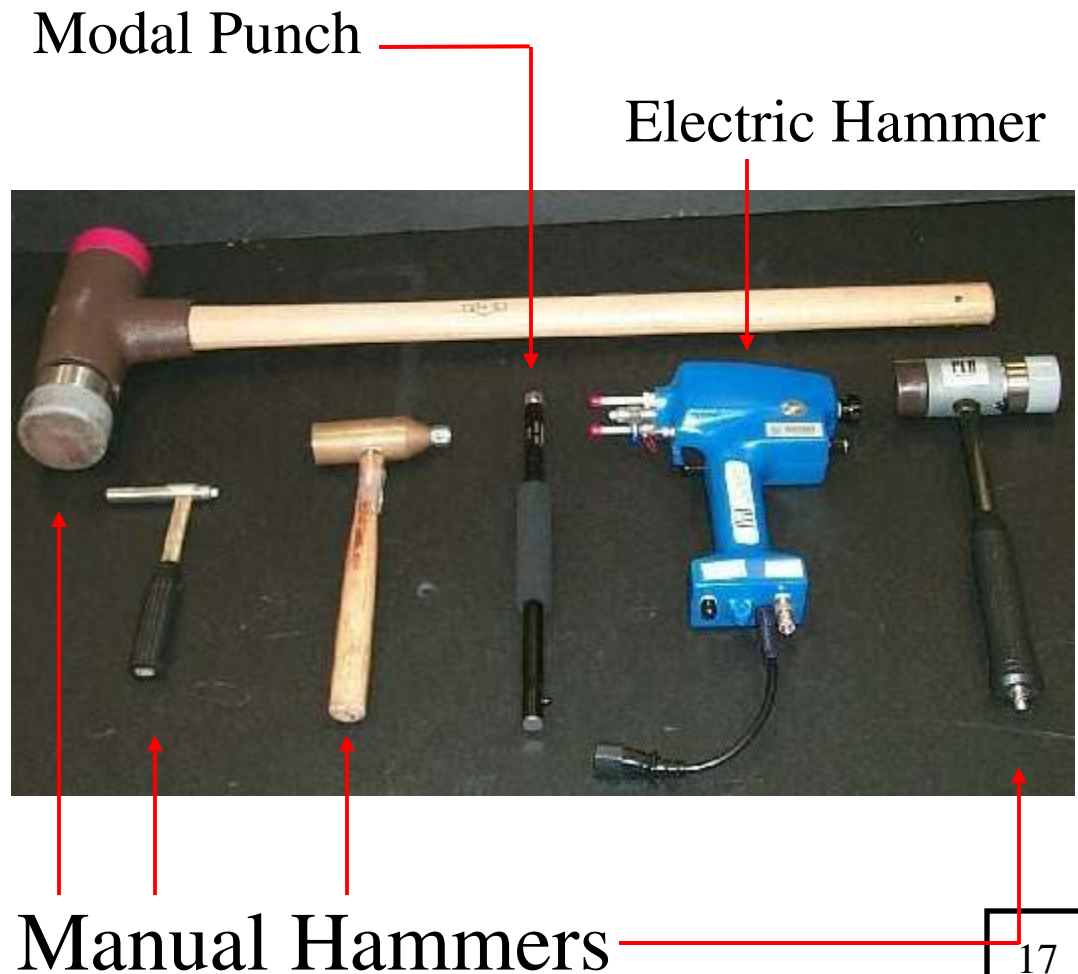

Impactors



Modal Excitation

Lightly Damped Systems

- The exponential window reduces leakage in the response signals

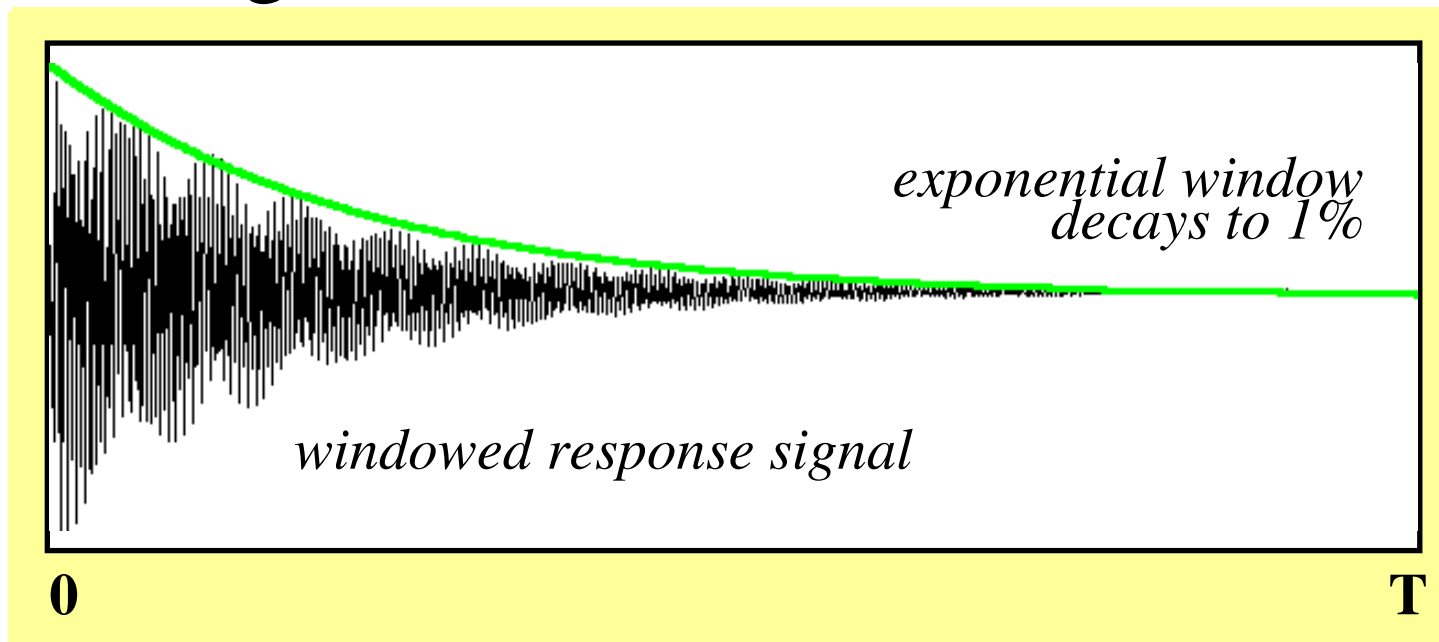

Use of the Force Window

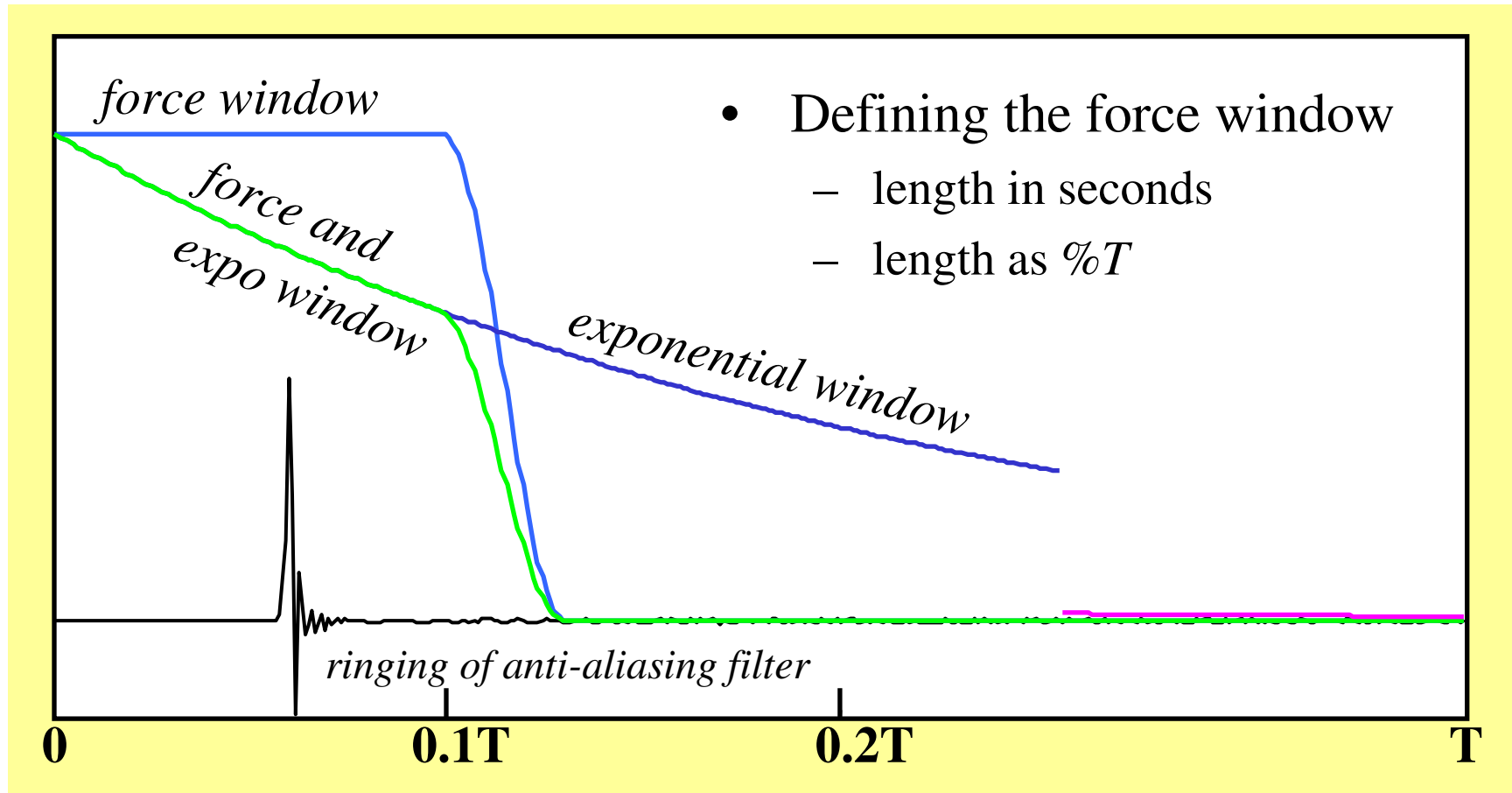

- The "length" of the force window = the duration of the leading unity portion

Exception to the Rule

- To improve impact testing FRF measurements, the force and exponential windows should *almost always* be applied to the time signals.
- The *exception* to this rule is when the measured signals contain significant components of periodic noise.
- Because of the frequency domain effects of the windows, the periodic noise must be removed from the data before applying the windows in the time domain.

Exponential Window Line Shape

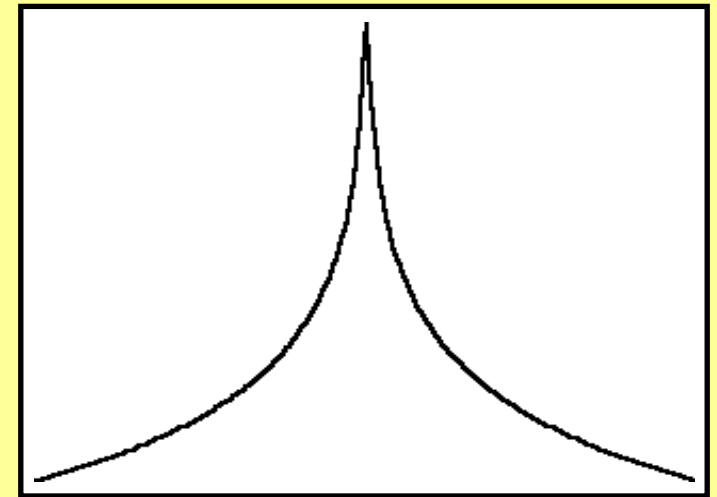

frequency axis

- DC-component
- electrical line noise
- periodic excitation sources

Removing Periodic Noise

- A pretrigger delay can be used to measure periodic ambient noise and DC offsets, which should be removed before the windows are applied.

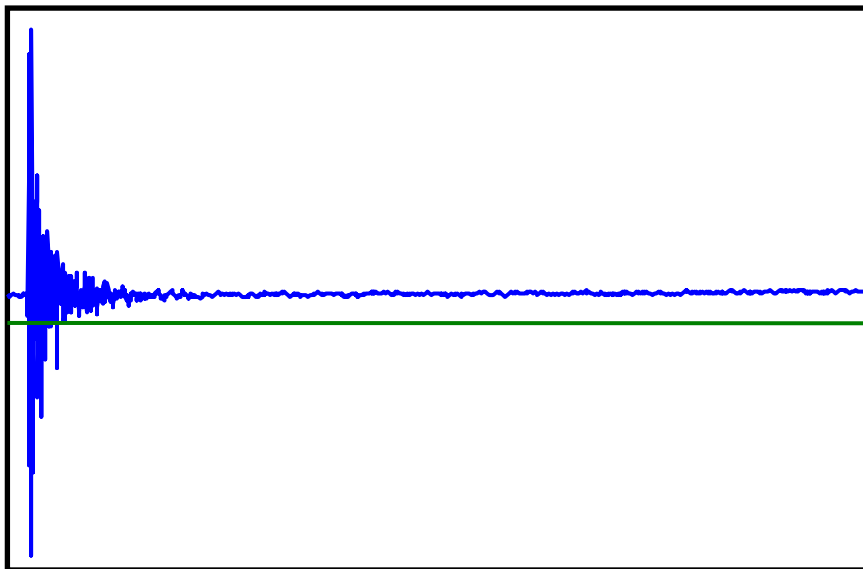

Time History

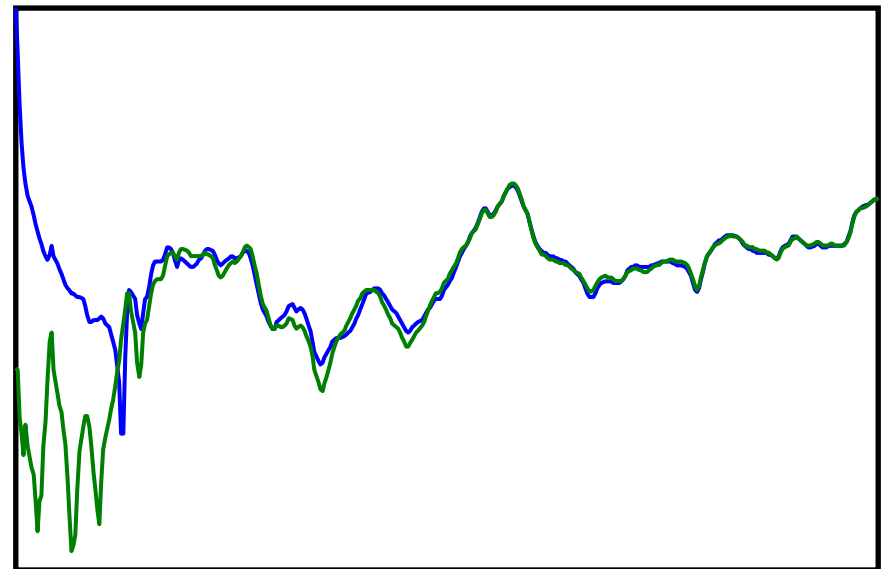

Fourier Spectrum

Step Relaxation Excitation

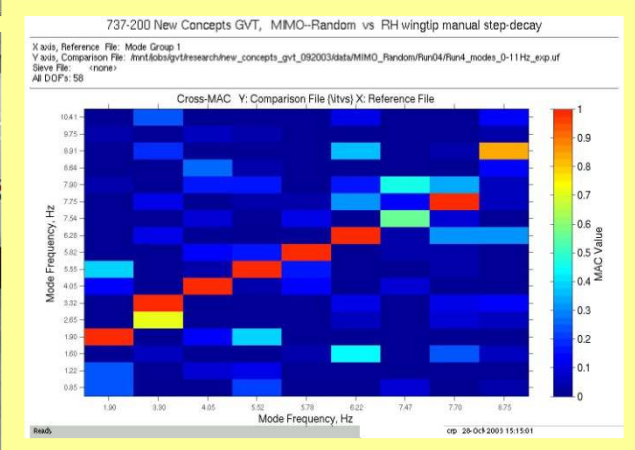
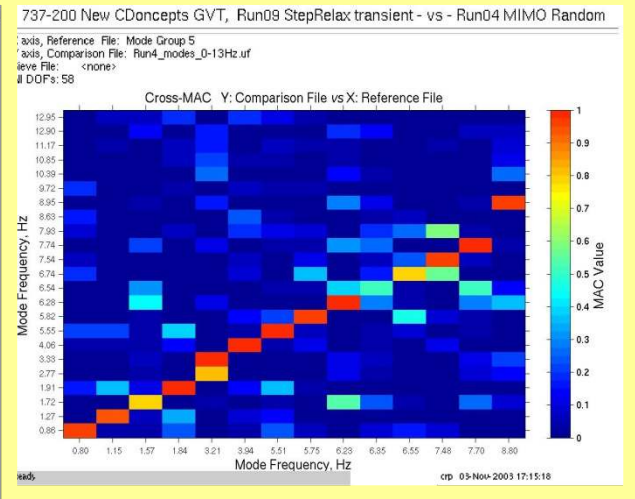
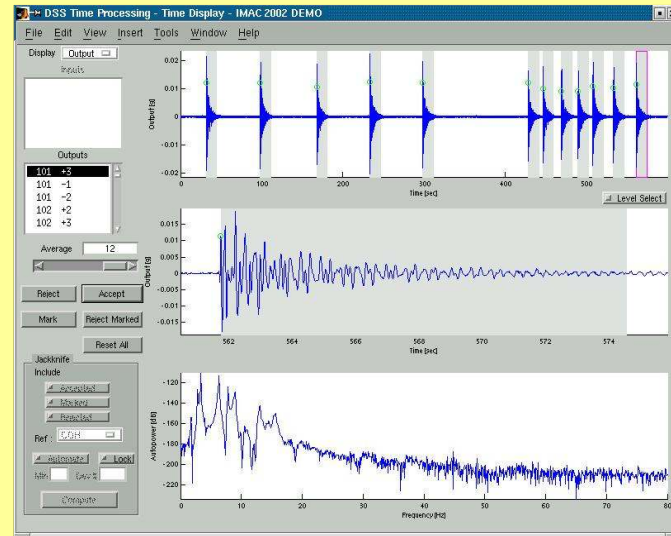

Typical modal test configuration: shaker

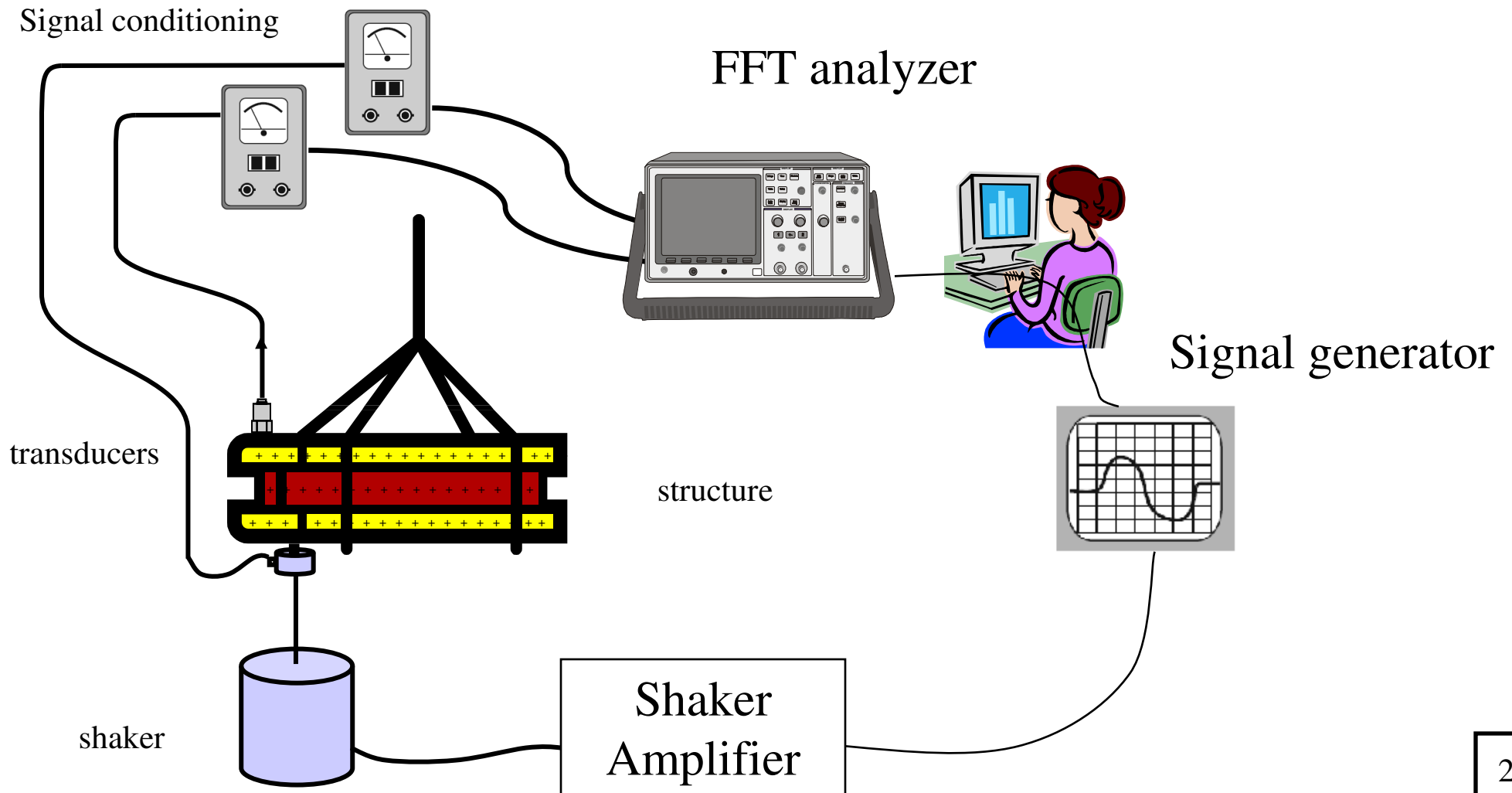

Types of Exciters

- Mechanical
 - Out-of-balance rotating masses
- Servo hydraulic
- Electromagnetic or Electrodynamic Shakers



Examples of Infrastructure Excitation



Drop Hammer



32 inch stroke – 1000 lb_f

Modal Excitation

Hydraulic vs. Electrodynamic

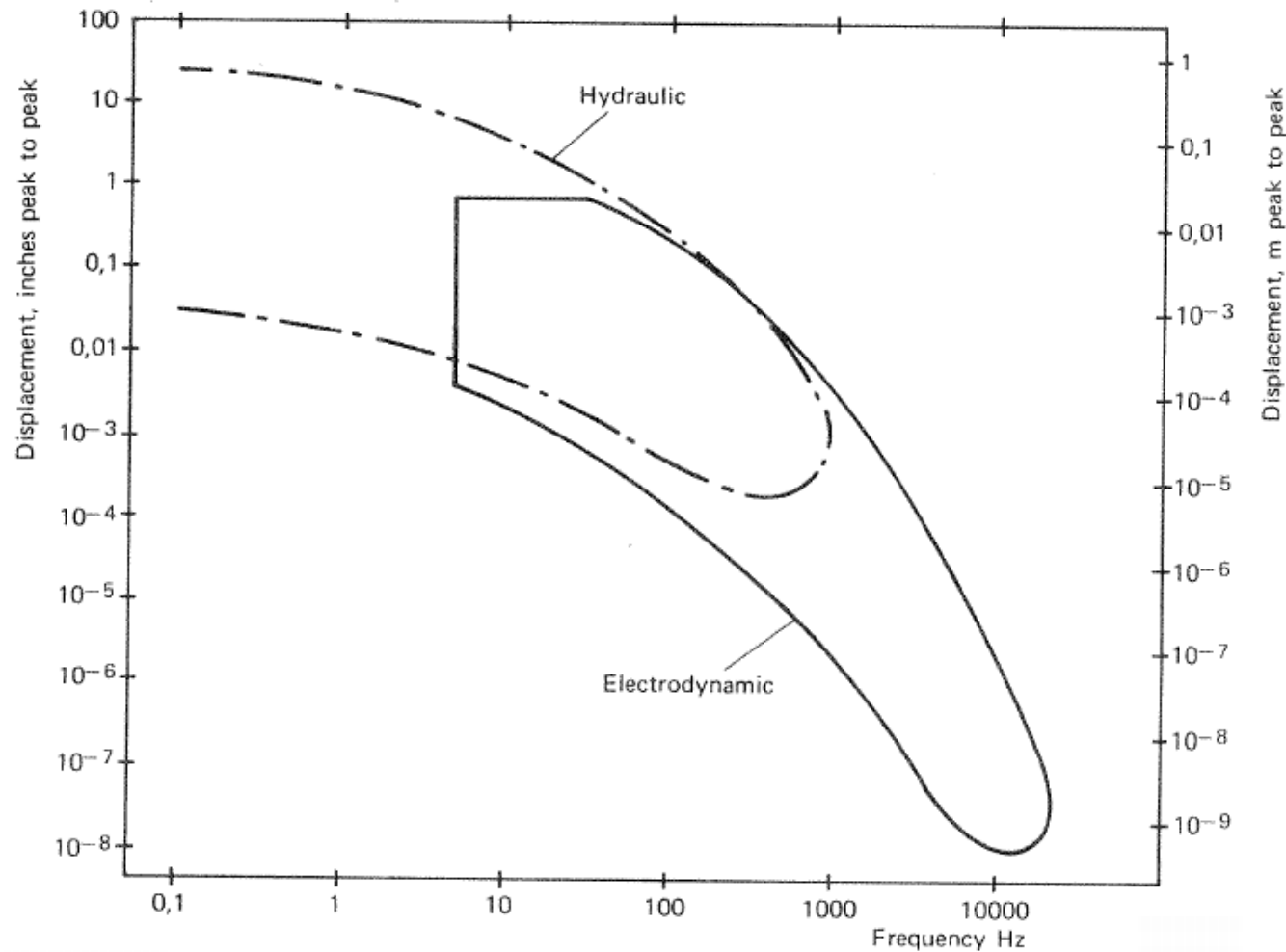

Useful operating regions of modern hydraulic and electro-dynamic vibration machines (after G.B. Booth)

Electrodynamical Shaker System

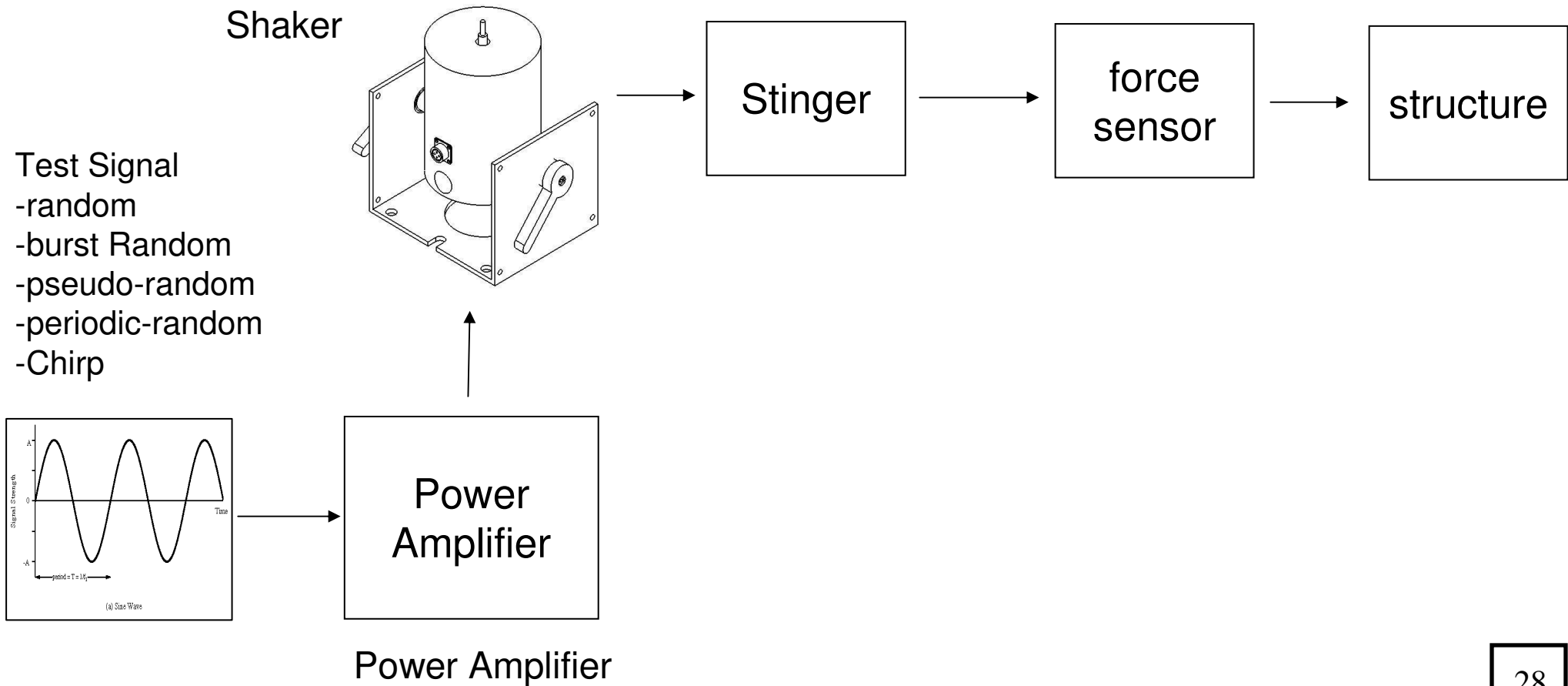

Typical Electrodynamical Shaker

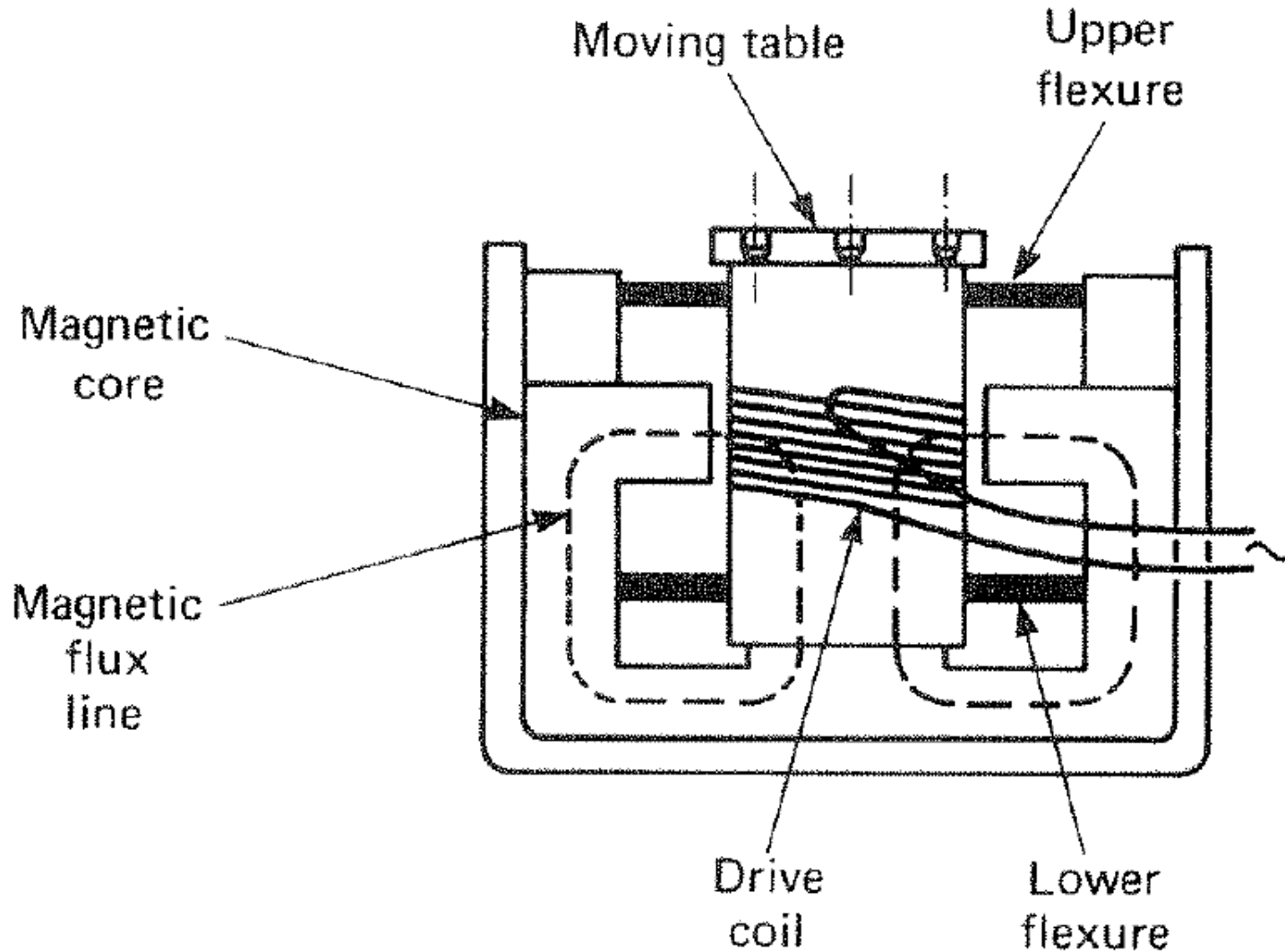

Michael Faraday

$$F = l \cdot B \cdot i$$

Modal Excitation

Typical modal shaker design

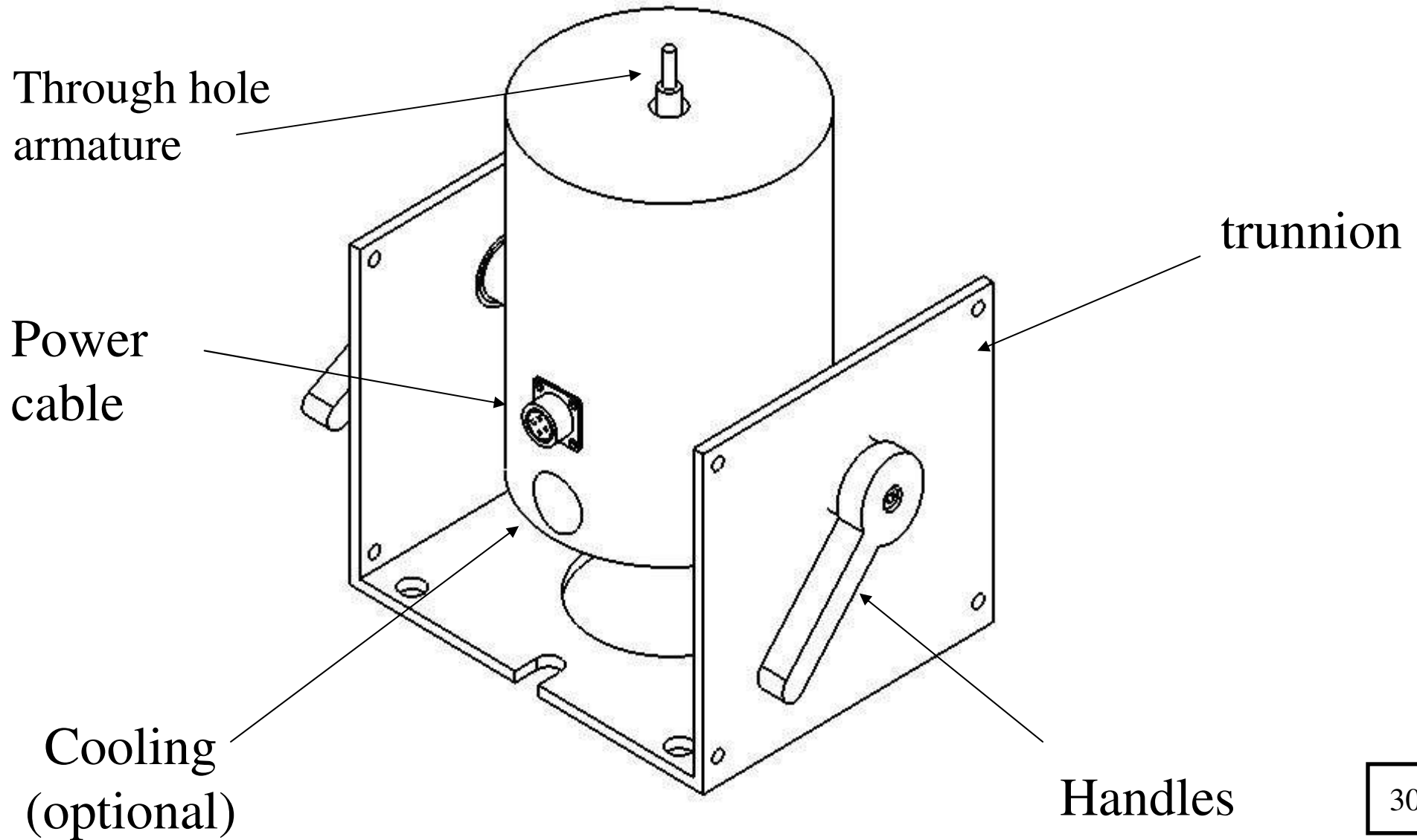

Important Shaker Considerations

- Excitation Point
- Boundary Conditions
- Fixturing
 - Exciter support systems
 - Alignment
 - Attachment to the structure: stingers

Excitation Points

- must be able to excite all modes of interest
 - node points of node lines
 - not good points if you want to suppress all modes
 - Good points if you want to suppress modes you are not interested on
- Pre-testing with impact hammer
 - Helps determine the best excitation point
- FEM (Finite Element Model)
 - Helps determine best excitation point

Boundary Conditions

Soft springs, bungee cords

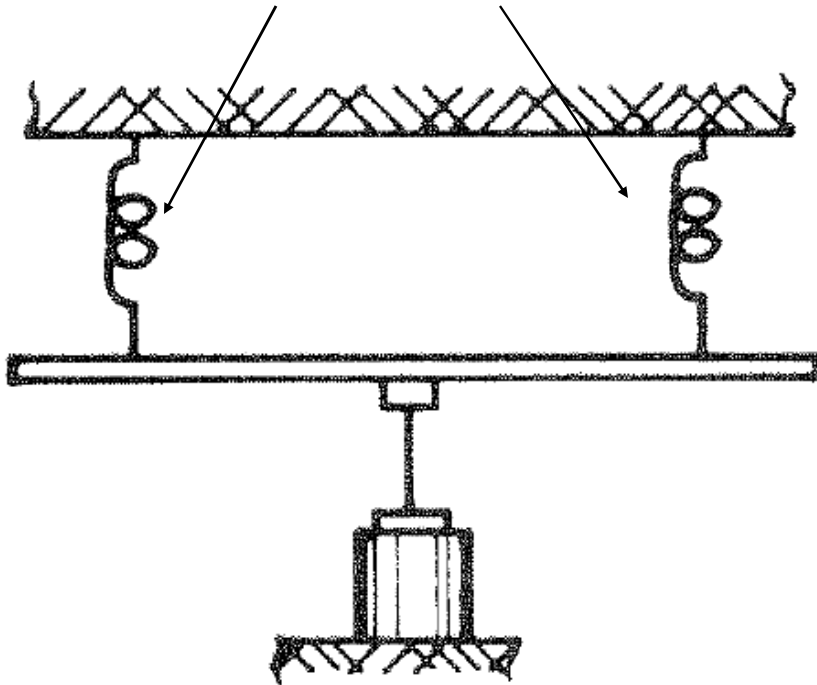

Free condition: highest rigid body mode frequency is 10-20% of the lowest bending mode

Drawing from: Ewins, D. J., Modal Testing: Theory and Practice



Boundary Conditions

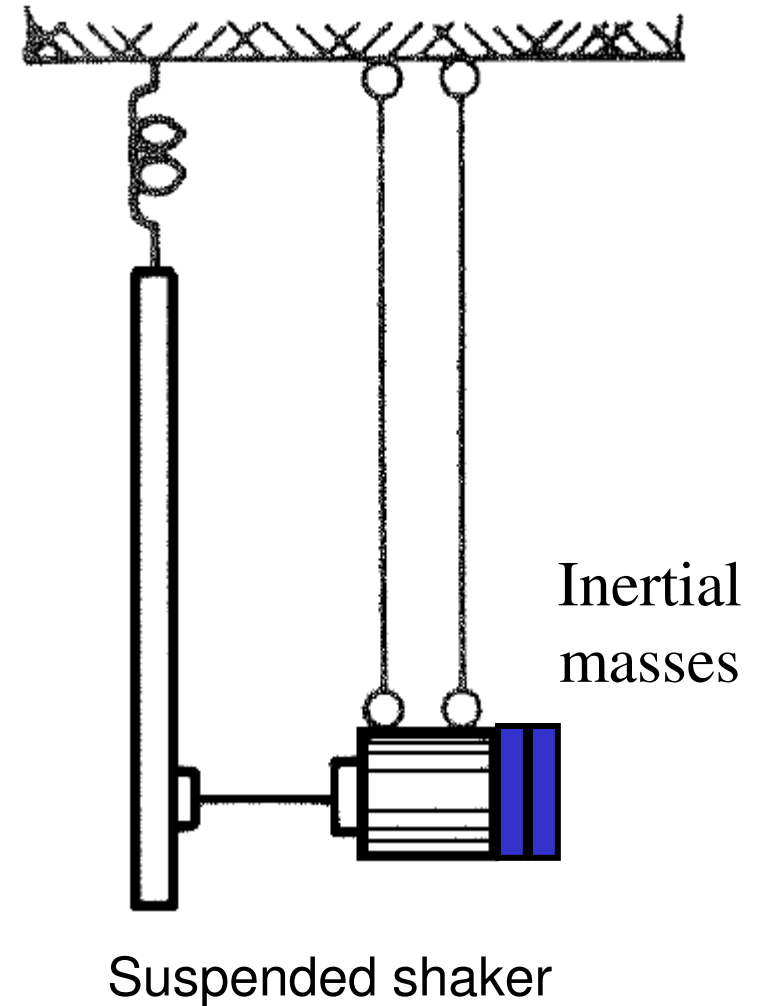

Boundary Conditions

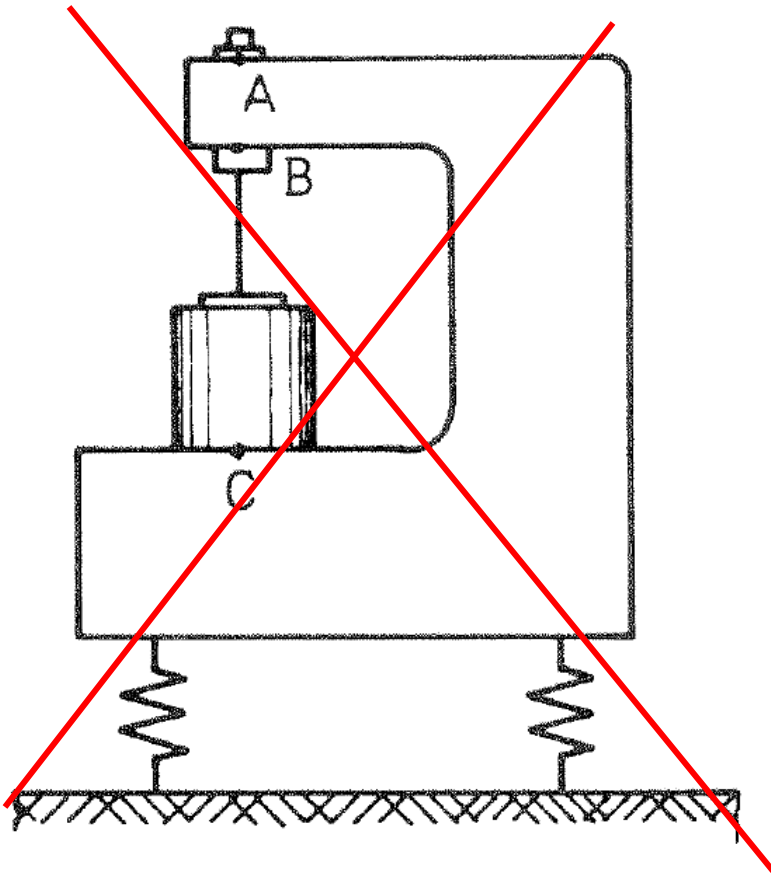

Unsatisfactory configuration

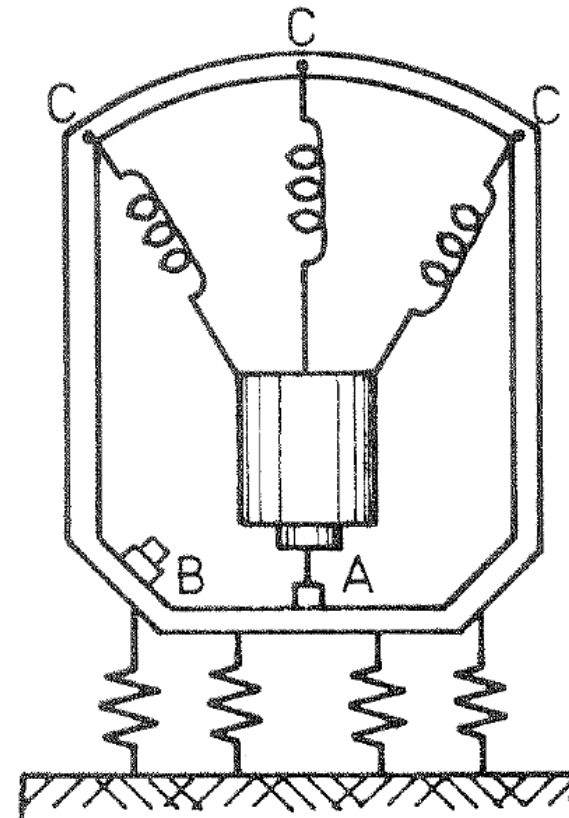

Compromise configuration

from: Ewins, D. J., Modal Testing: Theory and Practice, pp.101

Boundary Conditions

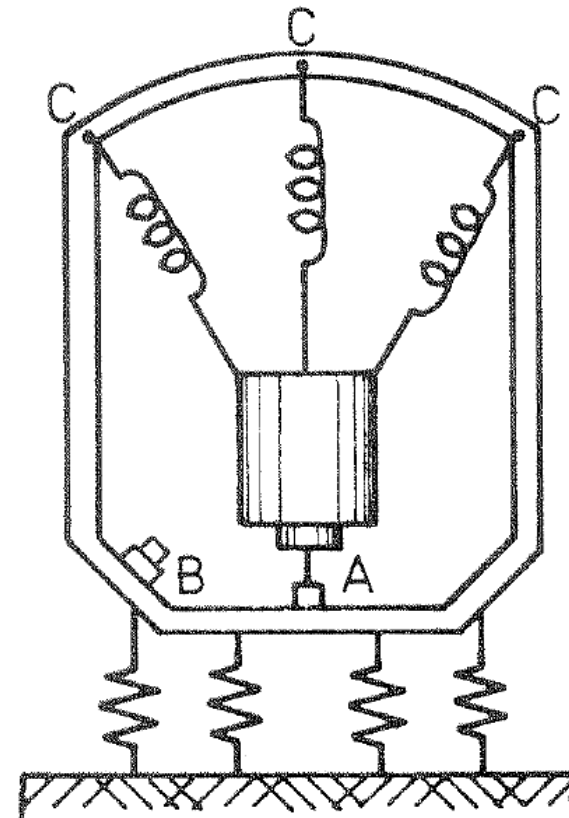

Compromise configuration

Boundary Conditions

- Free-free (impedance is zero)



Modal Excitation

Examples of Exciter Mounting



Dedicated Exciter
Support



Hot Glue and Duct
Tape Required

“Make Shift” Exciter
Support

Modal Excitation

Typical Installation

Modal Exciter

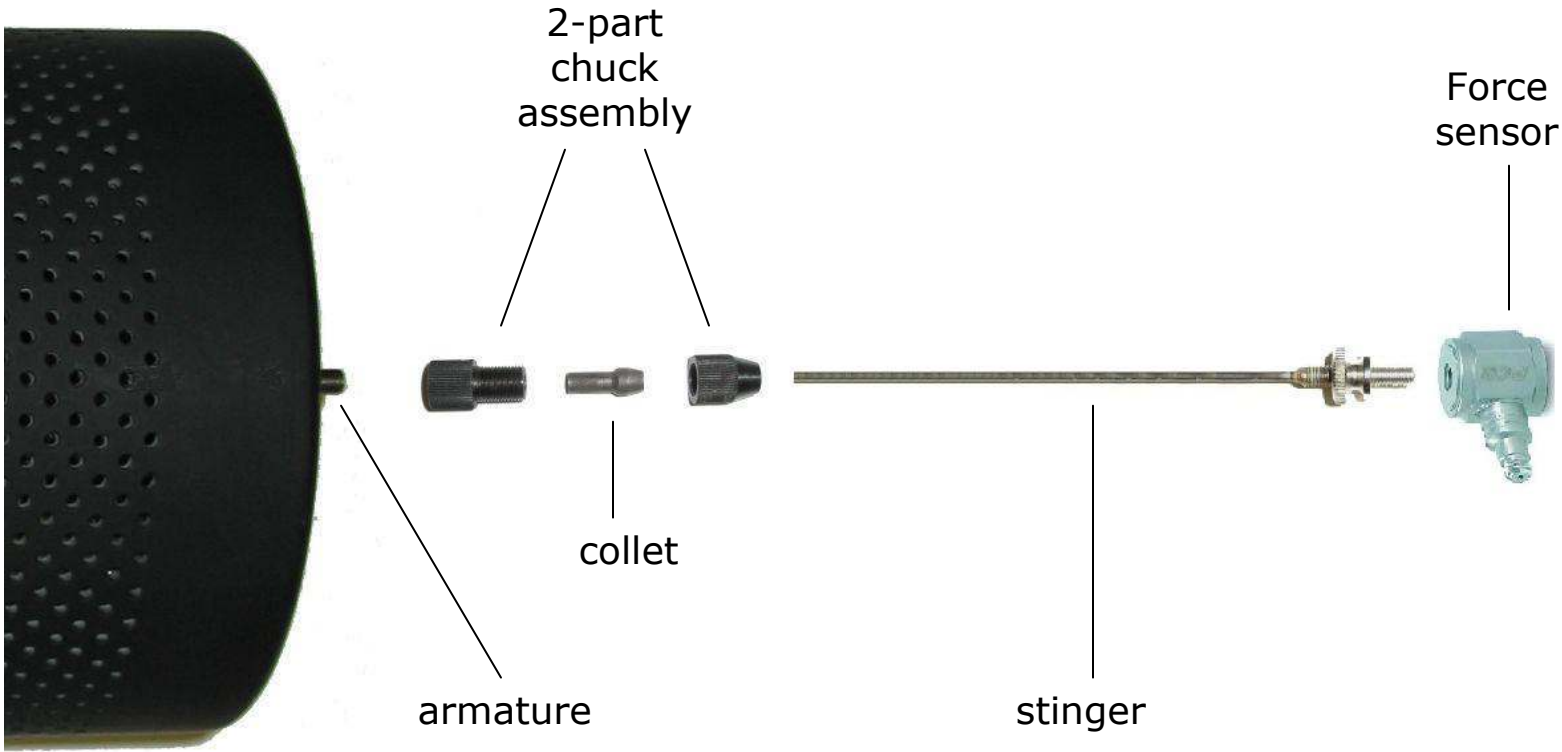

Through hole armature design

Shaker Alignment

- Fundamental to avoid side loads and measurement errors
- Through hole design and stingers → facilitate alignment
- Floor mounting
 - Trunnion → angle adjustment
 - Rubber/Dead blow hammer → minor adjusts
 - Hot glue or bolt to the floor
- Suspended Mounting
 - Shaker Stands
 - Special fixturings for major height adjustment
 - Turnbuckles, bungee cords
 - Inertial masses to minimize shaker displacements

Shaker Alignment

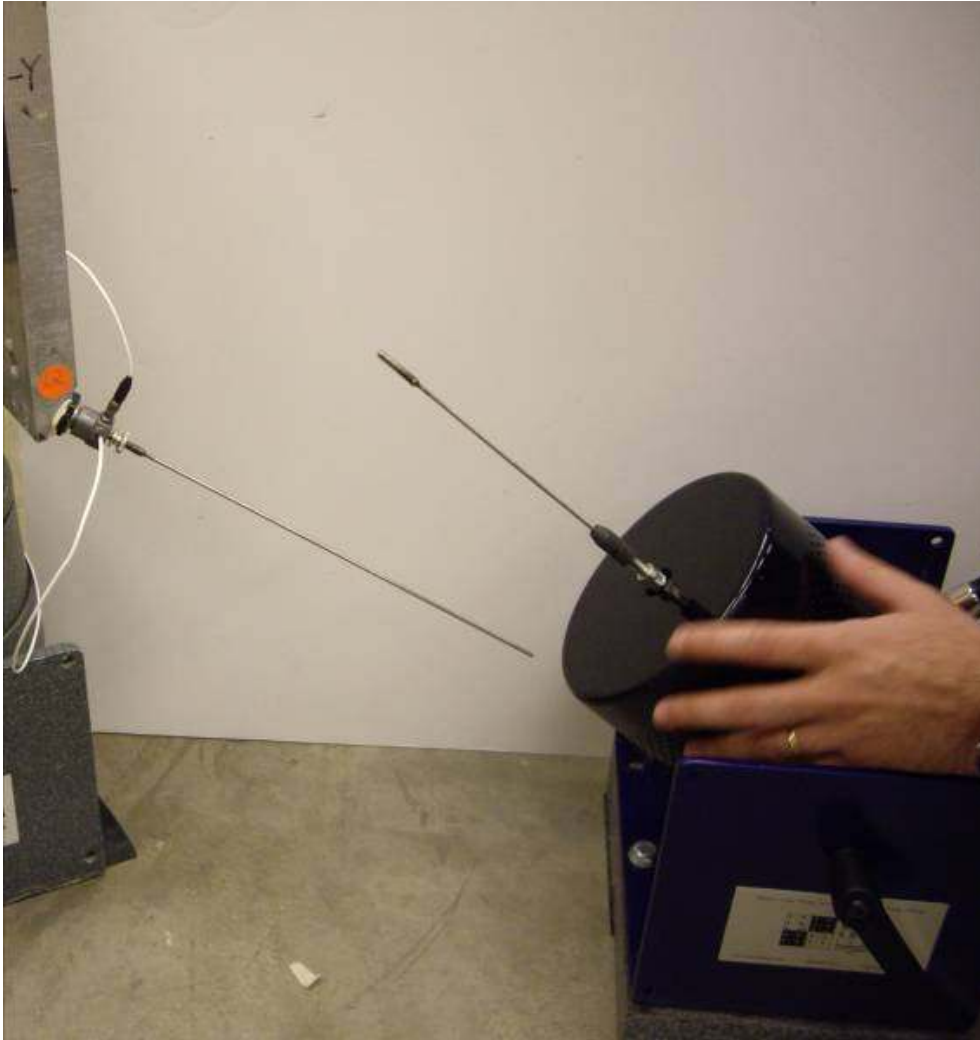

Modal Excitation

Laser Alignment Tools



Final Shaker Set Up



Installation Example



Click on the picture to start the movie

Stingers

- Link between the shaker and the structure
- stinger, quill, rods, push-pull rods, etc.
- Stiff in the direction of Excitation
- Weak in the transverse directions
 - No moments or side loads on force transducer
 - No moments or side loads on shakers

Stinger Types

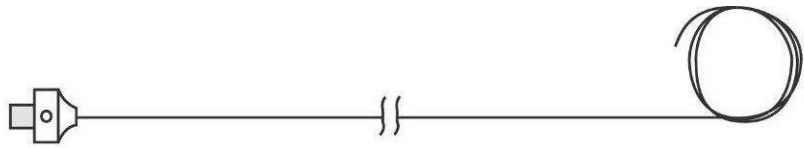

→ Piano wire



→ Modal stinger



→ Threaded metal rod



→ Threaded nylon rod

Stinger Installation

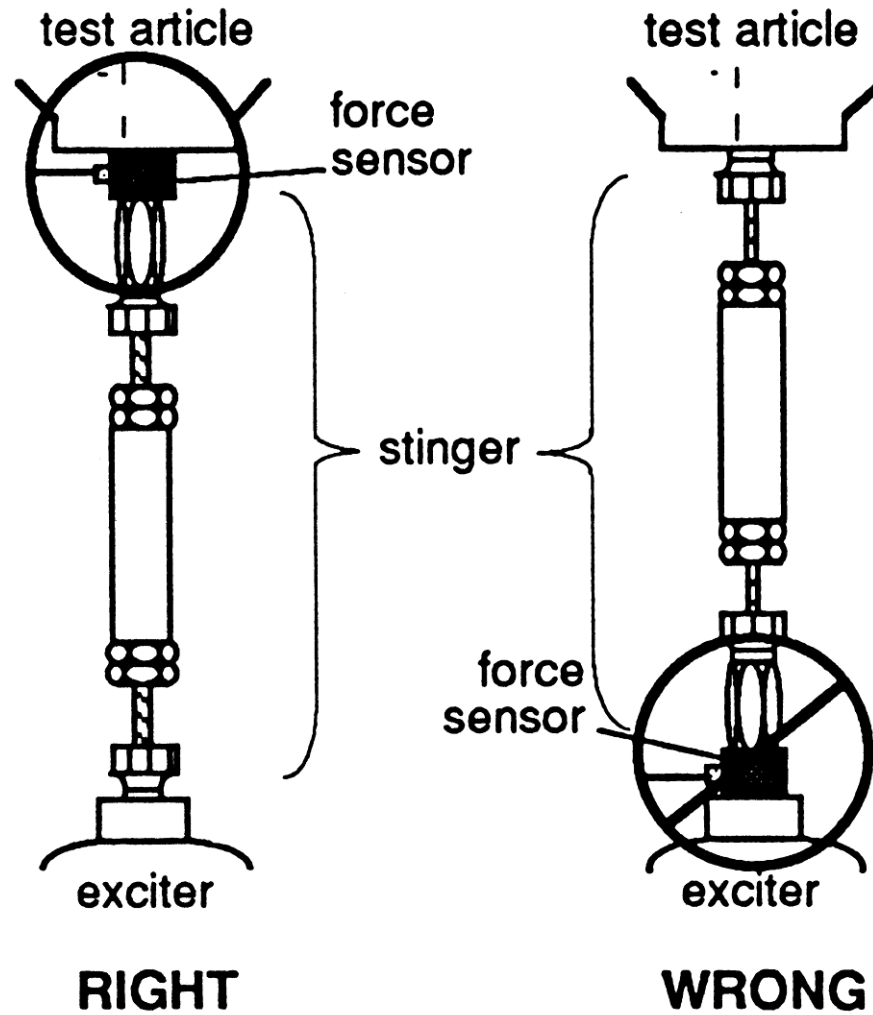

Stinger Considerations

- Rigid on excitation direction, weak on transverse direction
- Lightweight
- Buckling & alignment

Stinger Considerations

- Piano Wire: pre-tension

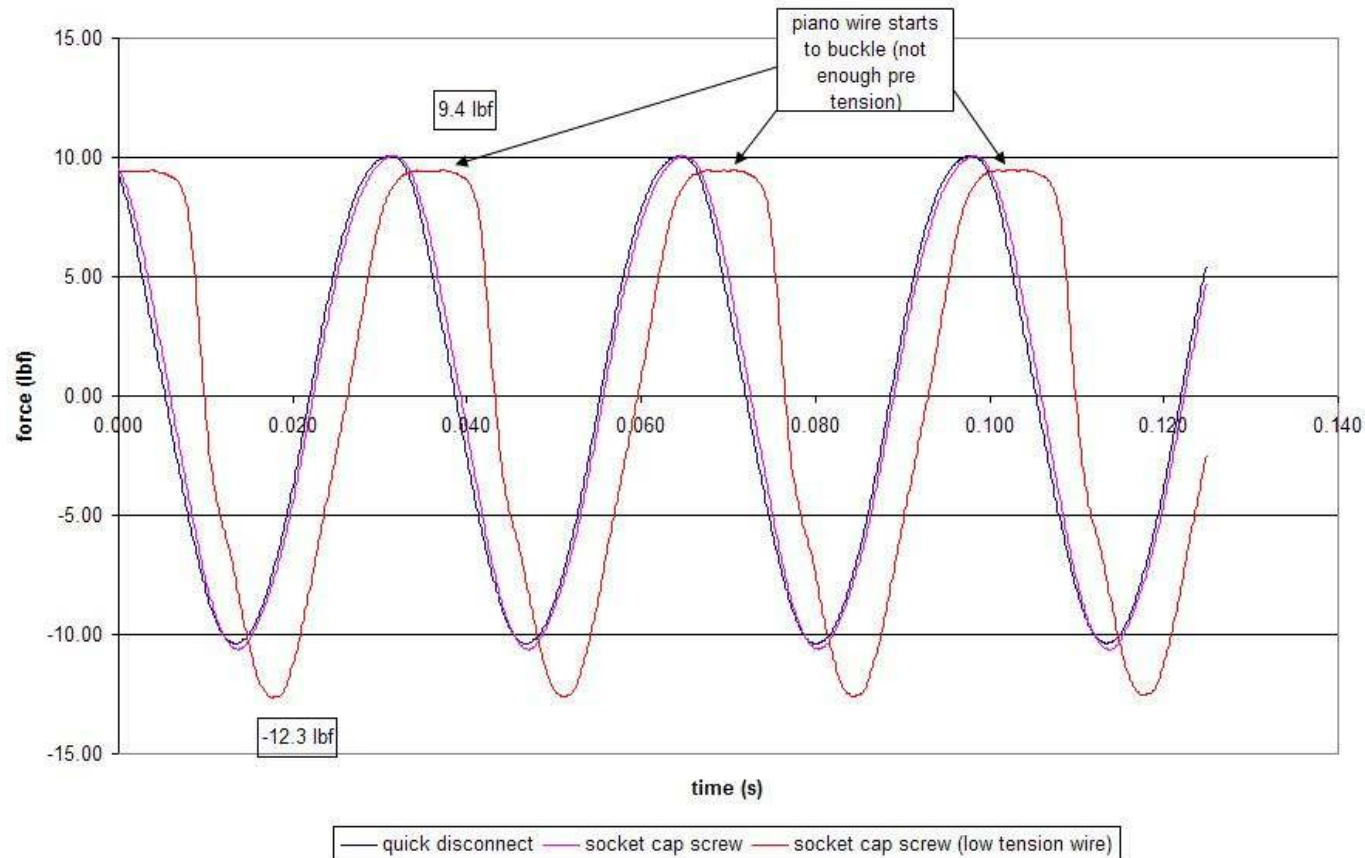

Sensor Considerations

- Normally piezoelectric (PE) force sensors are used for measuring excitation and PE accelerometers structure response
 - broad frequency and dynamic range
- Avoid bottoming mounting studs or stinger to the internal preload stud of the sensor
- Impedance head is a nice option for measuring drive point FRF

Sensor Installation

- Force Sensor or Impedance Head

Dental cement, hot glue

Superglue, stud, etc



Sensor Installation

- Force Sensor or Impedance Head



Shaker Amplifiers Features

- Match excitation device: shaker impedance
- Frequency range
 - Response down to DC
- Interlocks and protection
 - detects shaker over-travel and provides over current protection
- Voltage mode
 - Output proportional to signal input
 - Necessary for Burst Random Excitation Method
- Current mode
 - Compensates for shaker back EMF
 - Normal Mode testing
- Voltage / current monitoring outputs

Exciter Characterization

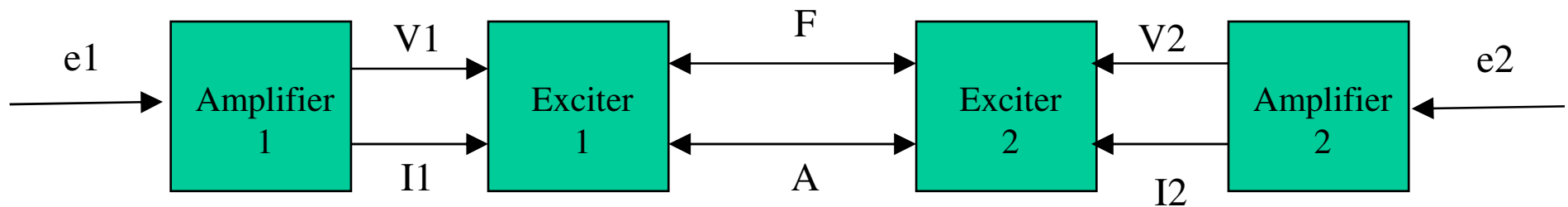

- Measuring Impedance Model of shaker using second shaker as boundary condition for first shaker and vice versa.

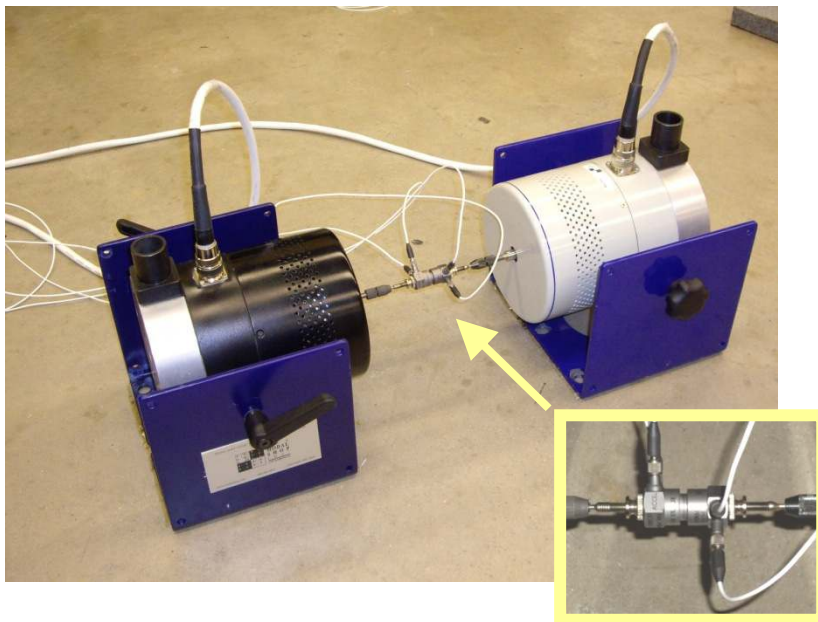

Impedance Heads

$$\begin{Bmatrix} F \\ A \end{Bmatrix} = \begin{bmatrix} H_{FI} & H_{FV} \\ H_{AI} & H_{AV} \end{bmatrix} \begin{Bmatrix} I \\ V \end{Bmatrix}$$

Testing Configurations

- SISO (Single Input Single Output)
- SIMO (Single Input Multiple Output)
- MISO (Multiple Input Single Output)
- MIMO (Multiple Input Multiple Output)

Force Monitoring

- During the measurement phase it is important to monitor the performance of the exciter. The force and/or reference accelerometers (impact testing) are common to the complete set of measurements. If these references are faulty then the complete set of measurements are compromised.
 - Force single input cases, the quality of the force measurement is important. Power Spectrums of the force are measured in real time and the driving point FRF are recorded for each response sensor configuration.
 - For the MIMO case the power spectrum for each input, the principle components of the inputs and set of reference FRF's are monitored in real time.

Example MIMO Force Monitoring

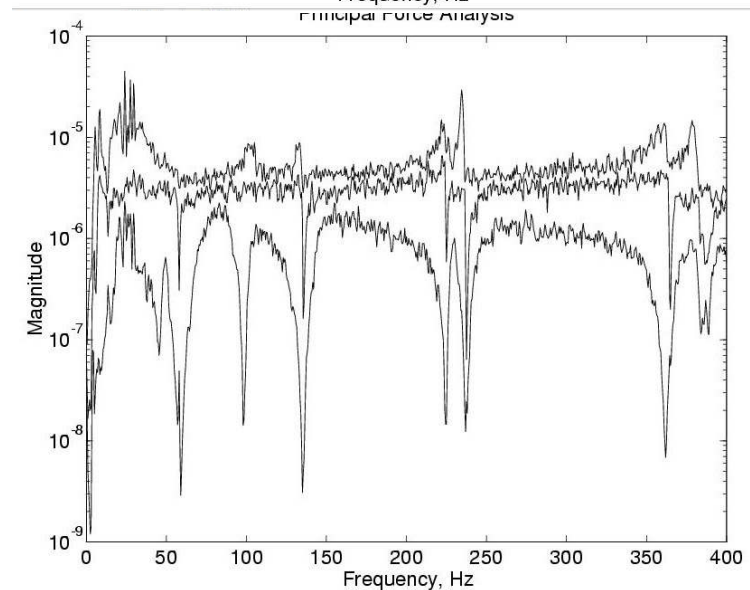
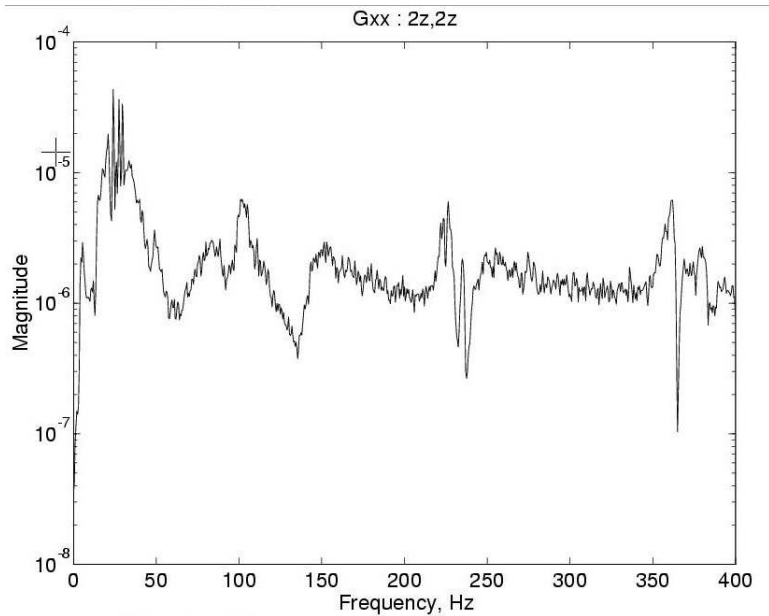
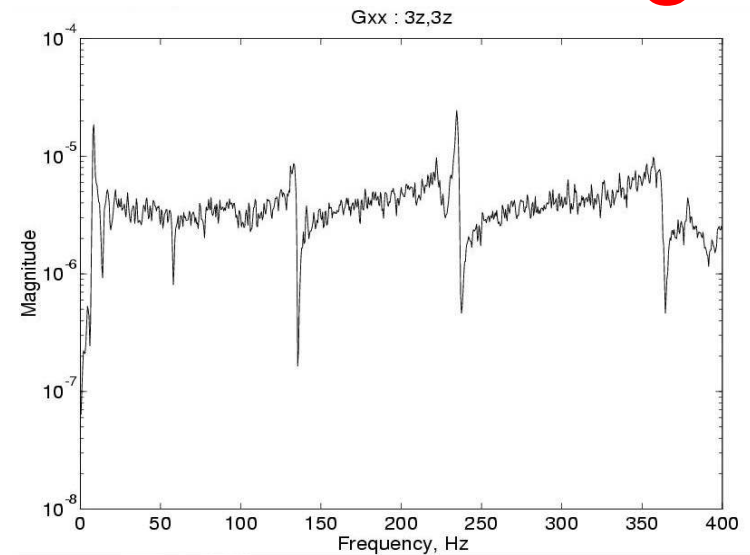
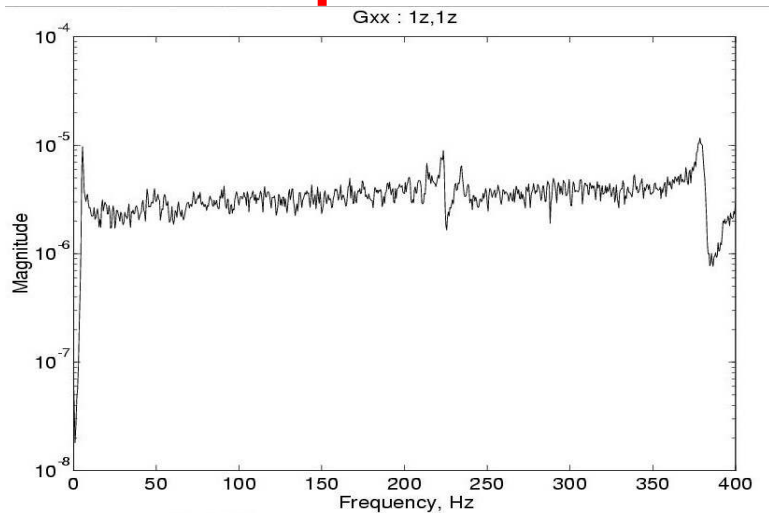

Before Release of Test Item

- At the conclusion of data acquisition phase a quick reduction of the data using a simple modal parameter estimation process should be performed.